







13 801 845



- 210mm projection
- circular normal flow
- hole diameter 37 mm
- 1/2" connection
- plug-link mounting
- max. flow 21.5 l/min at 3 bar flow pressure
- WRAS 2207003

	Matte Black	13 801 845-33
	Chrome	13 801 845-00
	Brushed Platinum	13 801 845-06
	Dark Chrome	13 801 845-19
	Brushed Chrome	13 801 845-93
	Brushed Dark Platinum	13 801 845-99

**Recommended miscellaneous**



- Concealed wall elbow -** 35 085 970 90
- max. recess depth 163 mm
  - min. recess depth 90 mm

13 801 845

mm [inches]

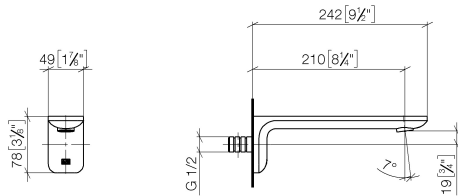

**Flow rate chart**



**Certificates**

LGA\_29012.

WRAS\_2207003.

13 801 845

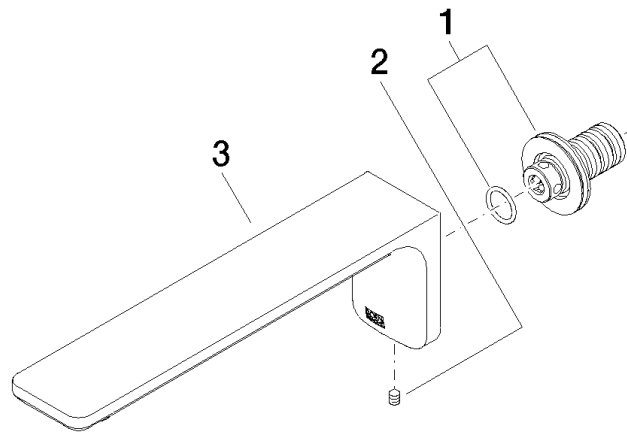

### Spare parts list

No.	Item Number	Name	Quantity used	Delivery time
1	90 24 03 108 00 90	nipple set	1	2
2	90 31 11 004 00 90	pin	1	2
3	90 11 84 014 02-33	spout	1	30